

Miele

HONEYCOMB CARE

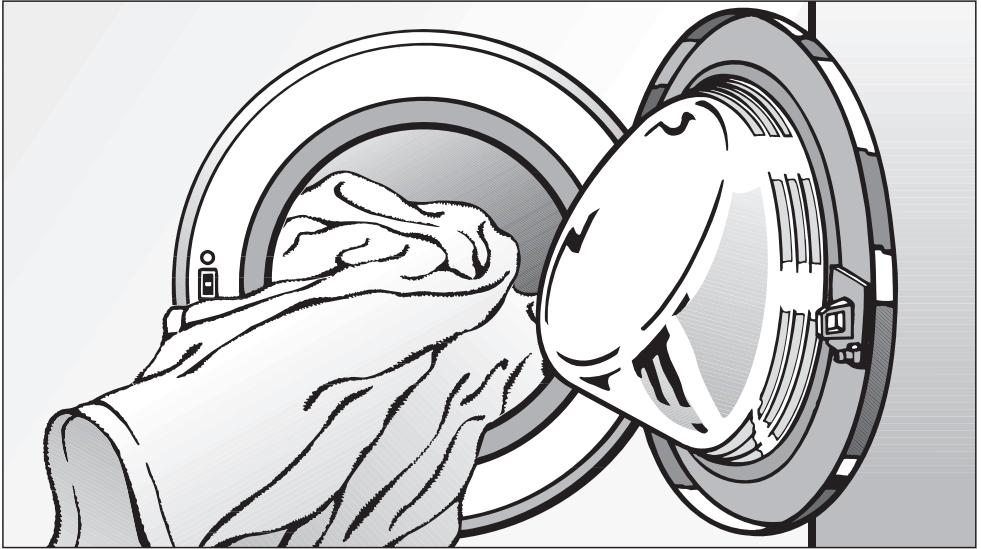

Operating instructions for Washing machine W 2240

To avoid the risk of accidents or damage to the machine it is **essential** to read these operating instructions before it is installed or used for the first time.



M.-Nr. 06 068 930

Caring for our environment

Disposal of the packing material

The transport and protective packing has been selected from materials which are environmentally friendly for disposal and can normally be recycled.

Ensure that any plastic wrappings, bags etc. are disposed of safely and kept out of the reach of babies and young children. Danger of suffocation!

Rather than just throwing these materials away, please ensure they are offered for recycling.

Disposal of your old appliance or machine

Electrical and electronic appliances / machines often contain materials which, if handled or disposed of incorrectly, could be potentially hazardous to human health and to the environment. They are, however, essential for the correct functioning of your appliance or machine. Please do not therefore dispose of your old machine or appliance with your household waste.

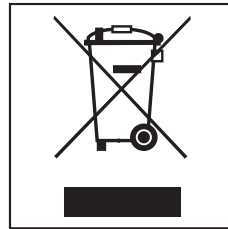

Please dispose of it at your local community waste collection / recycling centre and ensure that it presents no danger to children while being stored for disposal.

It should be unplugged or disconnected from the mains electricity supply by a competent person. The plug must be rendered useless and the cable cut off directly behind it to prevent misuse. See the "Warning and Safety" section of this booklet for further details.

Caring for our environment	2
Disposal of the packing material	2
Disposal of your old appliance or machine	2
Warning and safety instructions	6
Description of the machine	9
Special programmes	9
Delicates and Silks  programmes	9
Water plus system	9
Future updates (PC)	10
Control panel	11
Important control panel features	13
Programme selector	13
Additional option buttons	13
"Spin" button with indicator lights	13
Before using for the first time	14
Washing environmentally and economically	15
Energy and water consumption	15
Detergent	15
Additional options (Soak, Pre-wash, Intensive)	15
When drying with a tumble dryer	15
How to wash correctly	16
Brief instructions	16
Programme chart	17
Garment care label symbols	20
Before washing	21
Selecting a programme	22
Additional options	23
At the end of a programme	25
Adding or removing laundry after a programme has started	26

Contents

Interrupting a programme	27
Altering a programme once selected	27
Skipping a programme stage	27
To cancel or select a different programme	27
Programme sequence	28
Detergent	30
Water softeners	30
Washing with several components	30
Fabric conditioners and liquid starch	31
Automatic dispensing of fabric conditioner or liquid starch to laundry at the end of a programme	31
Adding fabric conditioner separately	31
Adding starch separately	31
Colour run and dye removers/dyes	31
Cleaning and care	32
E-Cloth	32
Extra cleaning	32
Cleaning the detergent dispenser drawer	33
Cleaning the water inlet filters	34
To clean the filter in the union in the open end of the inlet hose:	34
To clean the filter in the water inlet valve	34
Problem solving guide	35
The programme does not start.	35
The wash programme stops and a fault indicator light comes on.	36
A fault indicator light comes on but the wash programme continues as normal.	37
General problems or an unsatisfactory wash result	38
The drum door does not open when you press the Door button.	40
Opening the drum door in the event of a blocked drain outlet and/or power failure	41
Blocked drain outlet	41
Opening the drum door	42
Customer contact	43
Optional accessories	43

Installation and connection	44
Front view	44
Rear view	45
Installation surface	46
Installing the washing machine	46
Removing the transit fittings	46
Re-fitting the transit bars	48
Levelling the machine	49
Screwing out and adjusting the feet	49
Building under a continuous worktop/in a kitchen run	50
Washer and Dryer stack	50
The Miele water protection system	51
Connection to the water supply	52
Connection to the drainage system	53
Electrical connection U.K.	54
Consumption data	55
Note for test institutes:	55
Technical data	56
Programmable functions	58
Water plus system	58
Gentle action	60
Top-up rinse for Cottons	61
Memory Function	62
Soak	63

Warning and safety instructions

To avoid the risk of accidents and damage to the machine please read these instructions carefully before using it for the first time. They contain important information on its safety, use and maintenance. Keep these operating instructions in a safe place and ensure that new users are familiar with the content. Pass them on to any future owner of the machine.

Correct usage

Only use the washing machine to wash items which are specified by the manufacturer to be machine-washable on the wash-care label, and textiles composed of hand-washable wool or wool blend fabrics as well as satin, lace, silk and other hand-washable garments.

Any other applications may be dangerous. The manufacturer is not liable for damage resulting from improper use or operation.

This machine is not a toy! To avoid the risk of injury do not allow children to play on or near it or to play with the controls. Supervise its use by the elderly or infirm.

Technical safety

Before setting up the machine, check it for any externally visible damage. Do not install and use a damaged machine.

Before connecting the machine, ensure that the connection data on the data plate (voltage and connected

load) match the mains electricity supply. If in any doubt, consult a qualified electrician.

The electrical safety of this machine can only be guaranteed when continuity is complete between the machine and an effective earthing system which complies with local and national regulations. It is most important that this basic safety requirement is present and regularly tested and where there is any doubt the household wiring system should be inspected by a qualified electrician.

The manufacturer cannot be held liable for the consequences of an inadequate earthing system (e.g. electric shock).

Do not connect the machine to the mains electricity supply by an extension lead. Extension leads do not guarantee the required safety of the machine (e.g. danger of overheating).

The machine is built in accordance with current safety requirements. Unauthorised repairs could result in unforeseen dangers for the user, for which the manufacturer cannot accept liability. Repairs should only be undertaken by a Miele approved technician.

Ensure current is not supplied to the appliance until after maintenance or repair work has been carried out.

The machine is only completely isolated from the electricity supply when:

- it is switched off at the wall socket and the plug is withdrawn, or
- it is switched off at the mains, or
- the mains fuse is withdrawn.

Warning and safety instructions

■ This machine must only be connected to the on-site water supply using a new hose kit. Old hoses must not be re-used. Check the hose regularly for signs of wear and tear. Change in good time to avoid the risk of leaks and subsequent damage.

■ Faulty components must only be replaced by genuine Miele original spare parts. Only when these parts are fitted can the safety standards of the machine be guaranteed.

■ If the connection cable is faulty it must only be replaced by a Miele approved service technician to protect the user from danger.

■ In countries where there are areas which may be subject to infestation by cockroaches or other vermin, pay particular attention to keeping the machine and its surroundings in a clean condition at all times. Any damage which may be caused by cockroaches or other vermin will not be covered by the machine guarantee.

Use

■ This equipment may only be used in mobile installations such as ships, caravans, aircraft etc. if a risk assessment of the installation has been carried out by a suitably qualified engineer.

■ Do not install your washing machine in rooms where temperatures below freezing may occur. Frozen hoses may burst under pressure. The reliability of the electronic control unit may be impaired at temperatures below freezing point.

■ Before using the machine for the first time, check that the transit fitting at the rear of the machine has been removed (see section on "Installation"). During spinning, a transit fitting which is still in place may result in damage to both the machine and adjacent furniture or appliances.

■ Turn off the stopcock if the machine is to be left for any length of time (e.g. holiday), especially if there is no floor drain (gully) in the immediate vicinity.

■ Flooding danger
If hooking the drain hose into a wash basin, check that the water can drain off quickly enough to prevent the sink from overflowing. Make sure the drain hose is secure, so that the force of the water flowing out of the hose does not dislodge it. Otherwise this will result in flooding.

■ Take care to ensure that foreign objects (e.g. nails, pins, coins, paper clips) do not find their way into the machine with the laundry. These may damage components of the machine (e.g. suds container, drum), which in turn can result in damage to the laundry.

Warning and safety instructions

■ If the correct amount of detergent is dispensed, the machine should not need to be descaled. If, however, you do wish to descale the machine only use proprietary non-corrosive descaling agents and strictly observe the instructions on the packaging. If in doubt, contact the Miele Customer Service Dept. or your Miele Dealer.

■ Textiles which have been pre-treated in solvent based cleaning agents must be thoroughly rinsed in clean water before being washed in the machine.

■ Never use solvent based cleaning agents in this machine, as this may result in damage to component parts and create toxic fumes. Such detergents also pose a fire and explosion hazard.

■ Only use dyes specified by the manufacturer as being suitable for use in a domestic washing machine. Always observe the manufacturer's instructions carefully.

■ Colour run and dye removers contain sulphur compounds which can cause damage such as corrosion. Do not use these products in this machine.

■ Always make sure the drum is stationary before reaching in to remove washing. Reaching into a moving drum is extremely dangerous.

Safety with children

■ This machine is not a toy! To avoid the risk of injury do not allow children to play on or near it or to play with the controls. Supervise its use by the elderly or infirm, and supervise children whilst you are operating the machine.

■ For machines with a 'porthole' door, remember that the porthole glass will be hot when washing at very high temperatures. Do not let children touch it.

Accessories

■ Accessory parts may only be fitted when expressly approved by Miele. If other parts are used, guarantee, performance and product liability claims will be invalidated.

Disposal of your old machine

■ Before discarding an old machine, switch it off at the wall socket and unplug it. Render the plug useless. Cut off the cable directly behind the appliance to prevent misuse. This should be done by a competent person.

■ The manufacturer cannot be held liable for damage caused by non-compliance with these Warning and Safety instructions.

Your machine also has the following special programmes in addition to the standard Cottons and Minimum iron programmes.

Special programmes

– Silks

Hand-washable fabrics which crease easily and do not contain wool can be washed in the *Silks*  programme (30°C temperature only).

– Woolens

Hand-washable or machine-washable wool or wool blend fabrics can be washed in the *Woolens*  programme. If the garment care label does not specify a temperature, wash using the cold setting.

– Quick wash

This is a Cottons programme for small loads of very lightly soiled fabrics.

– Automatic

Suitable for small loads of garments made from man-made fibres and cotton garments which can be washed together. Sort according to colour.

– Separate rinse

Suitable for rinsing and spinning articles which have been hand washed.

Delicates and Silks programmes

In these programmes, the laundry is washed and spun very gently to reduce creasing and the amount of ironing required, thus providing "Easy care" for your laundry.

Water plus system

The water level for washing and/or rinsing is increased. For *Cottons* and *Minimum iron* programmes an additional rinse can also be selected.

Description of the machine

Future updates (PC)

The indicator or check light marked PC is the interface used by Miele service technicians during servicing work for testing purposes and for updating the machine's programme data.

Description of the machine

Control panel

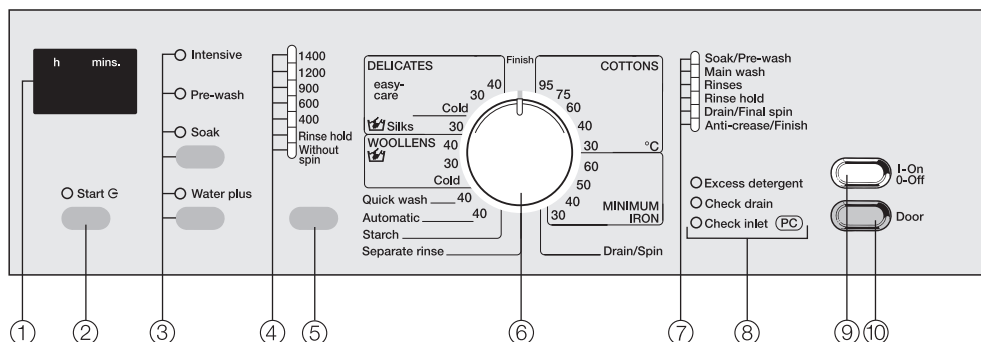

① Display

See the following page for more information.

② Start button

Starts the wash programme

③ Additional option buttons

Additional options can be added to the basic programme.

Use the top button to select either the *Intensive*, *Pre-wash*, or *Soak* option or a combination of these options.

Use the lower button to select the *Water plus* option.

Indicator light on = option selected

Indicator light off = option not selected

④ Indicator lights for spin speed, Rinse hold or Without spin

⑤ Spin button

For selecting the final spin speed, Rinse hold or Without spin

⑥ Programme selector

For selecting the wash programme and temperature for that programme. The programme selector can be turned clockwise or anti-clockwise

⑦ Programme sequence indicator lights

Show which section of the wash programme has been reached

⑧ Check lights

⑨ I-On/0-Off button

For switching the machine on or off or interrupting a programme

⑩ Door button

Opens the machine door

Description of the machine

Programme duration

After a programme has started, the maximum programme duration (wash time) will appear in the display in hours and minutes.

In the *Cottons*, *Minimum iron* and *Automatic* programmes, the machine measures the amount of water absorbed by the laundry and uses this to calculate the load during the first 10 minutes. If the machine recognises a smaller load it will shorten the programme time.

Programme	Max. time reduction	
	normal	intensive
Cottons	37 mins	52 mins
Minimum iron	12 mins	13 mins
Automatic	13 mins	18 mins

Soak

If the *Soak* additional option has been selected, the soak time is added to the programme duration in the display to give a total running time.

Important control panel features

Programme selector

The programme selector is used to set the basic wash programme and the temperature for that programme.

Additional option buttons

Additional options can be added to the basic programme.

Use the top button to select either the *Intensive*, the *Pre-wash* or the *Soak* option or a combination of these options.

Use the lower button to select the *Water plus* option.

The indicator light will come on to show that the additional option has been selected. If an additional option is chosen, which is incompatible with the basic programme, it cannot be selected.

"Spin" button with indicator lights

Select the spin speed.

Press the "Spin" button to select a different spin speed. You cannot select a spin speed higher than the maximum allowed for the basic wash programme chosen.

The indicator lights show the speed selected.

Wash programme	rpm
Cottons	1400
Minimum iron	900
Delicates	600
Silks	400
Woollens	1200
Quick wash	1400
Automatic	900
Separate rinse	1200
Starch	1400
Drain/spin	1400

You can also omit the final spin

■ Press the "Spin" button to reach:

– Rinse hold

The laundry is not spun and remains suspended in the final rinse water. This reduces creasing if the laundry is not going to be removed from the drum immediately after the end of the programme.

To continue the programme select a spin speed. When the programme is finished the *Anti-crease/Finish* light will come on. Turn the programme selector to the *Finish* position and press the *door* button to open the door and remove the laundry.

– Without spin

The laundry is not spun. After the water has been drained away the machine goes straight into the anti-crease stage. Spinning between the rinses is also omitted in this setting.

Before using for the first time

Before using the machine for the first time ensure that it is correctly installed and connected. See the relevant section under "Installation". Also check that the fluff filter is securely tightened. Otherwise there is a risk of water leakage during use.

For safety reasons spinning is not possible until the machine has been prepared for using for the first time. To activate the spinning function you must run a wash programme without laundry and without detergent.

Using detergent could result in an excessive build-up of foam.

This also activates the ball valve. The ball valve prevents detergent escaping from the suds container into the sump during a wash programme, thus making maximum use of the detergent.

- Open the stopcock.
- Press the *I-On/O-Off* button in.
- Turn the programme selector to *Cottons 40°C*.
- Press *Start*.

When this programme has finished turn the programme selector to *Finish*. Your washing machine is ready for using for the first time.

Washing environmentally and economically

Energy and water consumption

- Water consumption and energy usage are determined by the size of the load.
- Use the *Automatic* or the *Quick wash* programme for smaller amounts of laundry.
- When smaller amounts of laundry are washed in the *Cottons* programmes, the automatic load recognition system will reduce the amount of water, time and energy used. This may mean that the programme duration alters during the course of the wash programme.
- Instead of the *Cottons 95°C* programme, use the *Cottons 60°C* programme together with the *Intensive* additional option. This will give an energy saving of between 35% and 45%. The programme duration will be longer. This combination is sufficient for most levels of soiling. For stubborn or old stains, use the *Soak* option.

Detergent

- Do not exceed the amount of detergent recommended by the manufacturer on the packaging.
- Reduce the amount of detergent with smaller loads (approx. $\frac{1}{3}$ less than the amount recommended can be used when washing a half load).

Additional options (Soak, Pre-wash, Intensive)

Select:

A wash programme without any additional options for light to normal soiling where there are no obvious marks.

A wash programme together with the *Intensive* option for normal to heavily soiled laundry with visible staining.

- Use the additional option *Soak* instead of *Pre-wash*. If *Soak* is followed immediately by a main wash the same suds are used.

When drying with a tumble dryer

- Selecting the highest possible spin speed for the wash programme will save energy when drying in a tumble dryer afterwards.

How to wash correctly

Brief instructions

Please note:

To help familiarise yourself with how to use your washing machine please read the sections "Before washing", "Selecting a programme" and "At the end of a programme" in detail.

- 1 Sort the laundry into colours and fabric types

Selecting a programme:

- 2 Switch on the washing machine
- 3 Open the drum door
- 4 Load the drum
- 5 Close the drum door
- 6 Select a programme
- 7 Select a spin speed
- 8 Select any additional option required
- 9 Add detergent
- 10 Press the *Start* button













At the end of a programme:

- 11 Open the drum door
- 12 Remove the laundry
- 13 Switch off the washing machine
- 14 Turn the programme selector to the *Finish* position
- 15 Close the drum door









See the "Programme chart" in the next section for information on which programmes to use for different fabric types.

How to wash correctly



Programme chart

Cottons 30°C to 95°C     	
Fabric	Cottons and linen fabrics, e.g. bed linen, table linen, towelling, jeans, underwear, T-shirts, nappies.
Additional options	Soak, Pre-wash, Intensive, Water plus
Notes	<ul style="list-style-type: none"> – Only use the <i>Cottons 95°C</i> programme for heavily soiled laundry. – For heavy soiling or where staining is visible, use the <i>Intensive</i> additional option. – For laundry with stubborn soiling or soiling which has been left untreated for a while, select both the <i>Intensive</i> and <i>Soak</i> options. – For laundry with large amounts of dirt (e.g. dust, sand) use the <i>Pre-wash</i> additional option. – For dark coloured fabrics use a detergent for coloured fabrics, or liquid detergent.
Detergent	Powder detergent, detergent for coloured fabrics, liquid detergent, tablet detergent and liquid tab detergent.
Max. load	5 kg
<u>Note for test institutes:</u> For testing in accordance with EN 60456 you must use the <i>Intensive</i> option.	
Minimum iron 30°C to 60°C       	
Fabric	For garments made of synthetic fibres, mixed fibres and for easy care cotton shirts and blouses.
Additional options	Soak, Pre-wash, Intensive, Water plus
Notes	<ul style="list-style-type: none"> – For heavy soiling or where staining is visible, use the <i>Intensive</i> additional option.
Detergent	Powder detergent, detergent for coloured fabrics, liquid detergent, detergent for delicates, tablet detergent and liquid tab detergent.
Max. load	2.5 kg
<u>Note for test institutes:</u> For testing in accordance with EN 60456 you must use the <i>Intensive</i> option.	







How to wash correctly

Delicates cold to 40°C   	
Fabric	For delicate garments made of synthetic fibres, mixed fibres and easy care cotton shirts and blouses. Curtains, including net curtains, specified as machine-washable by the manufacturer.
Additional options	Soak, Pre-wash, Intensive
Notes	<ul style="list-style-type: none"> – For heavy soiling or where staining is visible, use the <i>Intensive</i> additional option. – Laundry remains relatively crease-free for easier ironing. – Dust in curtains usually makes using a programme with <i>Pre-wash advisable</i>. – For curtains made from delicate fabrics, reduce the spin speed or select Without spin.
Detergent	Liquid detergent for delicates.
Max. load	1 kg
Silks 30°C  	
Fabric	Hand-washable fabrics with no wool content, e.g. satin, lace and silk.
Additional option	Water plus
Notes	<ul style="list-style-type: none"> – Laundry remains relatively crease-free for easier ironing. – Place socks, tights, bras etc. in a washing bag.
Detergent	Liquid detergent for delicates.
Max. load	1 kg
Woollens cold to 40°C   	
Fabric	Machine-washable or hand-washable wool or wool blend fabrics. If the care label does not specify a temperature wash using the cold setting. Please note that hand-washable garments will not shrink, stretch, matt or felt beyond the accepted tolerance of the item.
Detergent	Liquid detergent for machine washable woollens.
Max. load	2 kg



How to wash correctly

Quick wash 40°C 	
Fabric	Very lightly soiled fabrics, which can be washed in the Cottons programme.
Additional option	Water plus
Notes	<ul style="list-style-type: none"> – Use less detergent (as for a half load). – If fabrics have a high proportion of man-made fibres it is advisable to programme the machine for "Gentle Action". See "Programmable functions". Note that this programme is not suitable for delicate items.
Detergent	Powder detergent, detergent for coloured fabrics, liquid detergent.
Max. load	2.5 kg
Automatic 40°C 	
Fabric	Small loads of garments made from man-made fibres and cotton garments which can be washed together. Sort according to colour.
Additional options	Soak, Pre-wash, Intensive, Water plus
Notes	<ul style="list-style-type: none"> – For heavy soiling or where staining is visible, use the <i>Intensive</i> additional option. – If fabrics have a high proportion of man-made fibres it is advisable to programme the machine for "Gentle Action". See "Programmable functions".
Detergent	Powder detergent, detergent for coloured fabrics, liquid detergent.
Max. load	3 kg
Starch	
Fabric	Table cloths, napkins, overalls, aprons.
Notes	– The laundry should be washed but not treated with fabric conditioner.
Max. load	5 kg
Separate rinse	
Fabric	Articles which have been washed by hand and only need to be rinsed and spun in the machine.
Max. load	5 kg
Drain/Spin	
Notes	– Drain only: Select <i>Without spin</i> . Do not use for Woollens.
Max. load	5 kg





Garment care label symbols

	Hand wash (If no temperature is specified use the lowest temperature or cold)
	Do not wash
	Dry clean
	Do not dry clean
	Suitable for chlorine bleaching
	Do not use chlorine bleach

Tumble dry

	At normal temperature
	At low temperature
	Do not tumble dry

Ironing

	Hot iron
	Medium hot iron
	Cool iron
	Do not iron

Garment care label symbols

Before washing

1 Sort the laundry

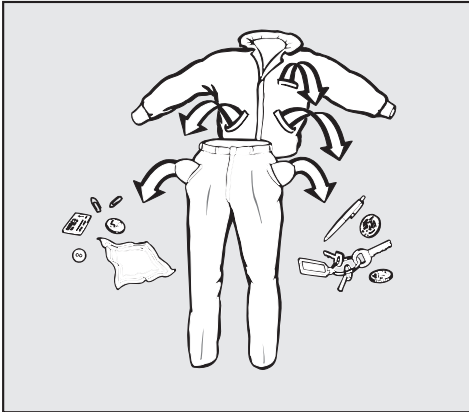

- Empty all pockets.

 Foreign objects (e.g. nails, coins, paper clips, etc.) can cause damage to garments and components in the machine.

- Badly soiled areas, e.g. collars and cuffs, and water soluble stains can be pre-treated with bar soap, liquid detergent or detergent mixed into a solution or paste.

With particularly stubborn stains ask your dry cleaner for advice.



 Do not use solvent-based cleaning agents in this machine.

- Sort the laundry by colour and by care label symbol. Most garments have a textile care label in the collar or side seam.

Dark textiles often contain excess dye and should be washed separately several times before being washed together with other garments. Always wash whites and coloureds separately.

Delicate textiles should be washed separately in a delicates programme (use a washing bag where appropriate).

- Curtains:
Remove lead weights and strips or place in a laundry bag.
- Underwiring and collar stiffeners:
Any loose wiring in bras, shirt collar stiffeners, etc. should be removed or sewn in.
- Knitted garments, trousers and jeans, T-shirts and sweat shirts:
Turn inside out, if recommended by the manufacturer.
- Close any zips, fasten hooks and eyes etc before washing.
- Fasten duvet covers to prevent smaller items rolling up inside them.

 Do not wash any items in this machine which are specified by the manufacturer as **not washable** on the care label. ()

Garment care label symbols

Selecting a programme

2 Switch on the washing machine

- Press in the *I-On/0-Off* button.

3 Open the drum door

- Press the *Door* button and open the drum door.

4 Load the drum

- Unfold the laundry and load loosely in the drum. To achieve best results it is advisable to make up mixed loads consisting of both large and small items. This improves the washing effect and helps distribute the load evenly to keep the machine stable and reduce the noise level during spinning.

To save energy and water try to load the maximum amount for the programme selected. However, be careful not to overload the machine. Overloading reduces the wash result and causes more creasing.

5 Close the drum door with a gentle swing

Make sure that no garments are caught between the drum door and seal.

6 Select a programme

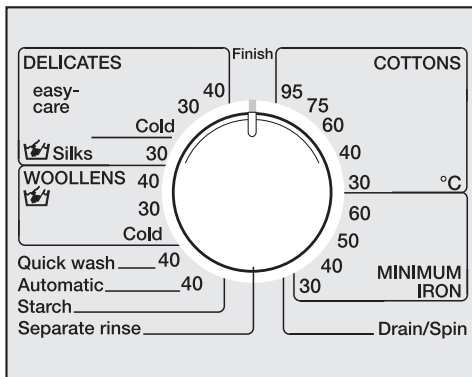

- Turn the programme selector to the required programme.

The maximum duration for the programme will appear in the display.

7 Select a spin speed

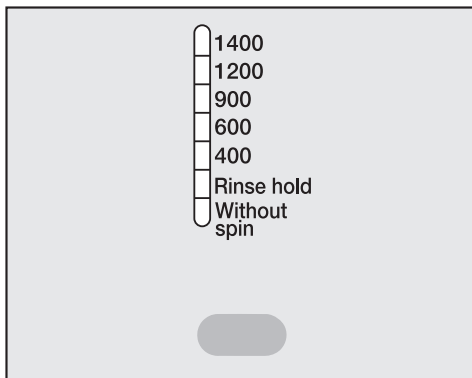

- Press the "Spin" button repeatedly until the indicator light for the spin speed you want comes on.

In some programmes the maximum spin speed is limited. The machine will not allow a higher spin speed to be selected.

Garment care label symbols

Additional options

8 Select additional option(s)

Additional options can be selected as long as they are compatible with the basic programme being used.

Each press of the top button selects the additional option in the following order: *Intensive* or *Intensive* and *Pre-wash* or *Intensive* and *Soak* or *Pre-wash* or *Soak* or no option selected.

Use the lower button to select or deselect the *Water plus* option.

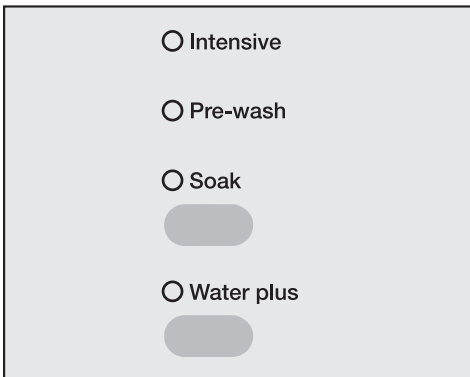

- Press the appropriate additional option button. Press the top button repeatedly until the indicator light for the additional option you want comes on.

Intensive

For normal to heavy soiling with visible staining.

The duration of the main wash is increased.

Pre-wash

For heavily soiled laundry and items with dried on stains.

Soak

For heavily soiled and stained items with protein stains (e.g. blood, fats and oils, cocoa).

- A length of time of between 30 minutes and 2 hours can be programmed in 30 minute increments for the soak process.
- The machine is set ex-works with a soak period of 2 hours.

To programme in a different soak period see "Programmable functions - Soak period".

Water plus

If you want to increase the water level for a wash process you can choose one of four options for the *Water plus* button. See "Programmable functions - Water plus system".

The machine is set at the factory so that the water level in the main wash and rinses will be increased if the *Water plus* button is pressed.

Garment care label symbols

9 Adding detergent

It is important to dispense the correct amount, because. . .

. . . too little detergent results in:

- Laundry not getting properly clean and with time it may become grey and hard to the touch.
- Greasy particles cling to the laundry.
- Limescale deposits on the heater elements.

. . . too much detergent results in:

- Excessive foam, which causes a low level of agitation and poor wash, rinse and spin results.
- higher water consumption because an extra rinse is automatically activated
- A burden to the environment.

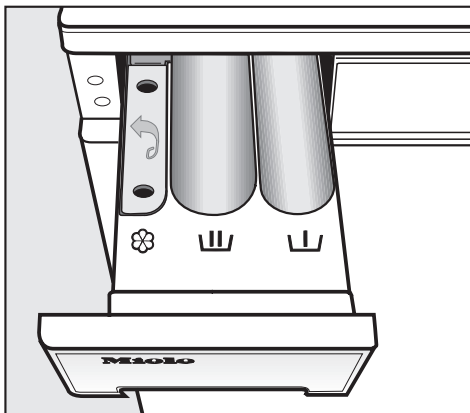

- Pull out the detergent drawer and place detergent in the compartments as follows:

 = Pre-wash
(if selected, add $\frac{1}{4}$ of the total amount recommended for the programme). This compartment is also used for starch formulations when starching separately.

 = Main wash
including the Soak period if selected

 = Fabric conditioner or liquid starch.

- Close the detergent drawer.

See section on "Detergent" for further information on detergent and the amount to dispense.

10 Press the **Start** button

This starts the programme. The maximum programme duration will then show in the display.

At the end of a programme

When the *Anti-crease/Finish* indicator light comes on the laundry can be removed from the drum. (This light stays on at the end of the programme and remains on until the selector is turned back to the *Finish* position).

11 Open the drum door

- Press the *Door* button.

12 Remove the laundry.

 Only remove laundry from the machine once the drum has stopped turning. Reaching into a moving drum is extremely dangerous and could result in injury.

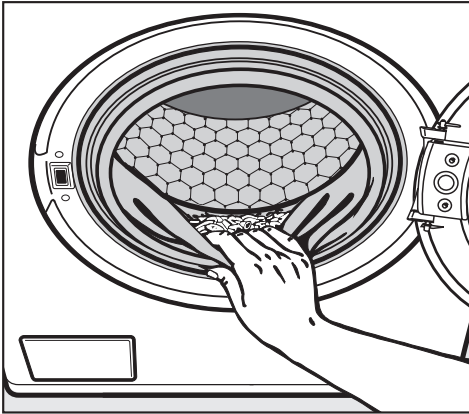

- Check the folds in the door seal for any small articles, e.g. buttons which may be lodged there.

Check that all items have been removed from the drum. Items left in the drum could discolour other items in the next wash or become discoloured themselves.

13 Switch off the washing machine.

- Press and release the *I-On/O-Off* button and turn the programme selector to *Finish*. The *Anti-crease/Finish* light will then go out.

14 Close the drum door

Otherwise there is the danger of objects being placed inadvertently in the drum. If these remained unnoticed and were washed in the next load, they could damage the laundry.

Garment care label symbols

Adding or removing laundry after a programme has started

Laundry can be added or removed after the programme has started when using the following programmes:

- Cottons
 - Minimum iron
 - Quick wash
 - Automatic
 - Starch
- Press the *Door* button in and hold it until the door springs open.
 - Add or remove items.
 - Close the door.

The programme will continue automatically.

Please note:

Once a programme has started the machine cannot recognise any adjustment to the load. For this reason if laundry is added or removed after the start of a programme, the machine will always complete the programme cycle assuming a full load which can lead to an increase in the time remaining for the programme shown in the display.

The door cannot be opened, if:

- the suds temperature is above **55°C**.
- the water is above a certain level.
- the programme has reached the *Final spin* stage.

Interrupting a programme

- Switch the washing machine off with the *I-On/0-Off* button.

To continue with the same programme:

- Switch the washing machine back on again with the *I-On/0-Off* button.

Altering a programme once selected

The machine will accept the following changes after a programme has started:

- at any time after the start, the spin speed can be changed within the limits for the programme.
- up to 6 minutes after the start, the *Water plus* additional option can be selected or de-selected and a different temperature can be selected for the programme in use.

After the start of a programme it is no longer possible to select a different programme.

If the programme selector is moved, the indicator light *Anti-crease/Finish* will start flashing. However, the programme sequence remains unaffected. The indicator light will go out again when the programme selector is moved back to the programme previously chosen.

Skipping a programme stage

- Turn the programme selector to *Finish*.

As soon as the programme sequence indicator light for the programme stage you want the programme to continue at starts flashing:

- Turn the programme selector back again to the appropriate programme within 4 seconds.

To cancel or select a different programme

















- Switch the washing machine off with the *I-On/0-Off* button.
- Turn the programme selector to *Finish*.

The programme has now been cancelled.

- Switch the washing machine back on with the *I-On/0-Off* button.
- Select a different programme.
- Press the *Start* button.

Garment care label symbols

Programme sequence

	Main wash		Rinses		Spinning	
	Water level	Wash rhythm	Water level	No of rinses	Rinse and interim spin	Final spin
Cottons		Ⓐ		2-3 ¹⁾	✓ ²⁾	✓
Minimum iron		Ⓐ		2-3 ³⁾	✓ ²⁾	✓
Delicates		Ⓑ		3	–	✓
Silks		Ⓓ		2	–	✓
Woollens		Ⓒ		2	✓ ²⁾	✓
Quick wash		Ⓐ		2	✓ ²⁾	✓
Automatic		Ⓐ		2	✓ ²⁾	✓
Starch	–	–		1	–	✓
Separate rinse	–	–		2	–	✓

 = Low water level

 = Medium water level

 = High water level

Ⓐ = Normal wash rhythm

Ⓑ = Gentle action

Ⓒ = Woollens

Ⓓ = Silks

Please continue reading for further details about the programme sequences.

This washing machine has fully electronic controls with automatic load recognition. This machine takes in the right amount of water required for the programme depending on the amount of laundry and its absorbency rate. This means that programme cycles and durations shown in the display can vary.

The programme sequences outlined below are based on the basic programme with a full load. Additional options which can be selected have not been taken into account.

The programme sequence indicator lights show the stage the programme has reached.

Special features in the programme sequences:

Anti-crease:

At the end of every programme, with the exception of the *Woollens* programme, the anti-crease action switches on for a maximum of 30 minutes. The door can be opened and laundry removed at any time during the anti-crease phase.

1) A third rinse takes place automatically if:

- there is too much foam in the drum
- a spin speed of lower than 700 rpm has been selected.
- *Without spin* has been selected

2) Rinse and interim spin:

There is a spin between the rinses.

3) A third rinse takes place automatically if:

- *Without spin* has been selected

Omitting rinse and interim spin:

Select *Without spin*.

Detergent

All modern detergents produced for automatic washing machines are suitable, including liquid, compact (concentrated), tablets, liquid tablets and special application detergents. Use dispensing aids, e.g. balls, if these are supplied with the detergent. Tablets are suitable for full loads but note that it may be impractical to reduce tablets for smaller loads. Some tablets do not dissolve as rapidly as others and may not be suitable for Quick wash programmes.



Woollens and knitwear containing wool mixtures and hand-washable garments should be washed using a detergent specifically designed for washing woollens.

Silk should be washed using a liquid detergent specifically designed for washing woollens. Do not use biological detergents on silk as the enzymes may damage the silk!

Instructions for use and recommended amounts for a full load are given on the detergent packaging.

Liquid detergent

Liquid detergent should be dispensed using a ball provided by the manufacturer for programmes without a pre-wash.

For programmes with a pre-wash you will need to purchase a special container from the Miele Spare Parts department which sits in the main wash compartment  of the detergent dispenser drawer. Add liquid detergent to this container for the main wash and to compartment  for the pre-wash.

The right amount to dispense will depend on the following:

- The quantity of laundry.
- The soiling level of the laundry.
 - Lightly soiled
No visible dirt or stains. Possibly slight body odour.
 - Normally soiled
Visibly dirty and/or just a few slight stains.
 - Heavily soiled
Stains and soiling clearly visible.
- The water hardness level.
 - Check with your local water supplier if you do not know the water hardness level in your area.

Water softeners

A water softener can be used to cut down on the use of detergents in extremely hard water areas. Dispense according to the amount specified on the packaging. First add detergent and then the water softener. Use a quantity of detergent as for soft water. Miele do not recommend connecting the machine to a household water softener.

Washing with several components

If you wash using several components (e.g. special application detergents), dispense them into compartment  in the following order:

1. Detergent
2. Water softener
3. Stain remover

This way the agents are distributed more efficiently.

Fabric conditioners and liquid starch

Fabric conditioners make garments soft to handle and help prevent static cling when tumble drying.

Starch stiffens and gives body to items of laundry, e.g. shirts, tablecloths and bed linen.

- Dispense according to the amount specified on the packaging.

Automatic dispensing of fabric conditioner or liquid starch to laundry at the end of a programme



- Add the fabric conditioner or liquid starch to compartment ☼. **Do not exceed the maximum level mark.**

The conditioner or liquid starch is automatically dispensed in the last rinse. At the end of the programme a small amount of water remains in the fabric conditioner compartment ☼.

If starching frequently, the dispenser compartment and especially the siphon tube and conditioner channel will need regular cleaning to remove any residual starch. See "Cleaning the detergent dispenser drawer". Do not add starch formulations or viscous liquid starch to the ☼ compartment as it will clog it up. See "Adding starch separately".

Adding fabric conditioner separately

- Add fabric conditioner to compartment ☼.
- Turn the programme selector to *Starch*.
- Select a spin speed.
- Press the *Start* button.

Adding starch separately

Use the separate *Starch* programme when using starch formulations or viscous liquid starch.

- Prepare and measure the starch in accordance with the manufacturer's instructions.
- Add starch to compartment ▮.
- Turn the programme selector to *Starch*.
- Select a spin speed.
- Press the *Start* button.

Colour run and dye removers/dyes

- Do not use colour run or dye removers in this washing machine.
- Dyes suitable for use in domestic washing machines can be used. However, please note that the salt used in the dyeing process can cause corrosion to stainless steel components in the machine if you dye frequently. Always observe the manufacturer's instructions carefully.

Cleaning and care

 Disconnect the machine from the mains electricity supply and withdraw the plug from the socket prior to cleaning the machine.

- Clean the casing with a mild non-abrasive detergent or soap and water. Wipe dry with a soft cloth.
- Clean the fascia panel with a damp cloth and wipe dry with a soft cloth.
- The drum can be cleaned using a suitable proprietary stainless-steel cleaning agent following the manufacturer's instructions on the packaging.

 Do not use solvents, abrasive cleaners, glass cleaners or all-purpose cleaning agents. These might damage plastic surfaces and other components because of the chemicals they contain. The washing machine must not be hosed down.

Extra cleaning

Carry out a hot wash (70°C or above) with powder detergent approx. every 6 weeks to help prevent deposits building up in the machine. These can occur when washing is mainly done at low temperatures, and also lead to unpleasant smells. If you have no reason to wash occasionally at this high temperature, then run a Cottons 95°C programme with detergent but no laundry at regular intervals.

E-Cloth

A microfibre "E-Cloth" is available from the Miele UK Spare Parts Department, Part number 98013530, which is suitable for cleaning surfaces such as stainless steel, glass, plastic and chrome without the use of chemicals. It can be washed 300 times.

Cleaning the detergent dispenser drawer

Remove detergent residues regularly.

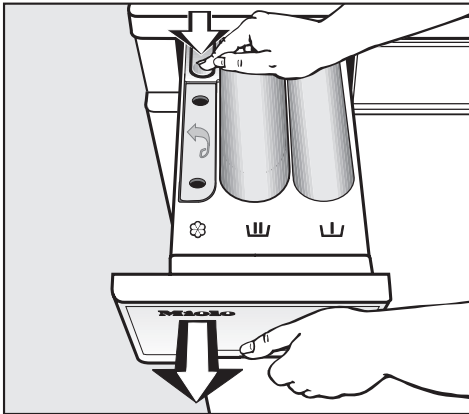

- Pull out the detergent dispenser drawer until a resistance is felt. Press down the release catch and at the same time pull the drawer right out of the machine.
- Clean the detergent drawer with warm water.

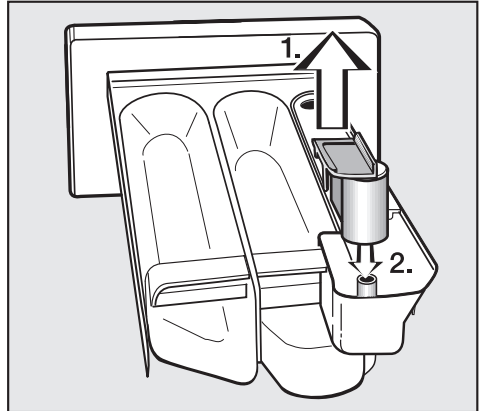

- Clean the siphon.
 1. Remove the siphon from compartment ⌘. Wash under running warm water. Clean the siphon tube in the same way.
 2. Replace the siphon.

Over time, detergent residue can build up in the water jets in the top of the detergent drawer housing.

- Before replacing the detergent drawer, use a bottle brush or similar to clean them out.

Cleaning and care

Cleaning the water inlet filters

The washing machine has two filters to protect the inlet valves.

These filters should be checked every six months or so, or more often if there are frequent interruptions to the water supply.

To clean the filter in the union in the open end of the inlet hose:

- First turn off the stopcock.

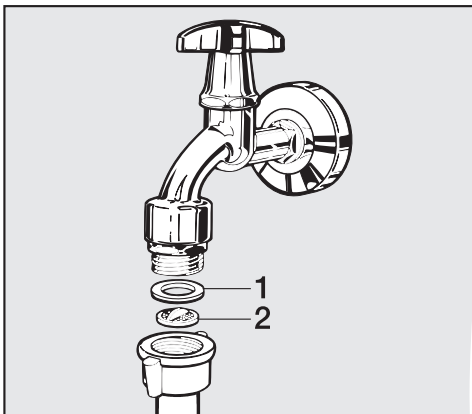

- Unscrew the threaded union connecting the free end of the inlet hose to the stopcock.
- Remove the rubber seal **1** from the recess.
- Using pointed pliers, take hold of the plastic filter bar **2**, remove the filter and clean it.
- Put the filter and seal back in the reverse order and reconnect the hose.
- Turn on the stopcock and check the connection is watertight. If it leaks, tighten the connection.

To clean the filter in the water inlet valve

- Using pliers, carefully loosen the ribbed plastic nut on the inlet valve and unscrew.

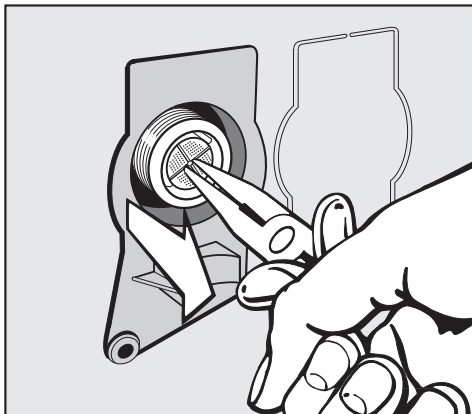

- Use pointed nose pliers to withdraw the plastic filter by the bar (see illustration). Clean, put back and secure.

The two filters **must** be put back in place after cleaning.

Problem solving guide

With the help of the following notes minor faults in the performance of the appliance, some of which may result from incorrect operation, can be put right without contacting the Service Department.

 Repair work to electrical appliances should only be carried out by a suitably qualified person in accordance with local and national safety regulations. Unauthorised repairs could be dangerous.

The programme does not start.

Problem	Possible cause	Remedy
The <i>Anti-crease/Finish</i> indicator light is not on, or the <i>Start</i> indicator light is not flashing.	There is no power.	Check that <ul style="list-style-type: none">– the mains plug is plugged in and switched on.– the fuse or circuit breaker has not tripped.
The programme does not start when <i>Drain/Spin</i> has been selected.	The washing machine has not been prepared for using for the first time.	Prepare the machine as described in "Before using for the first time".

Problem solving guide

The wash programme stops and a fault indicator light comes on.

Problem	Possible cause	Remedy ❶
The <i>Check drain</i> light flashes. "--" appears in the display.	The water outlet is blocked.	Clean the drain filter and the drain pump as described in "Problem solving guide - Opening the drum door in the event of a blocked drain outlet and/or power failure".
	The drain hose has been fixed too high.	The maximum drain height is 1 m.
The <i>Check inlet</i> light flashes. "--" appears in the display.	The water inlet is blocked.	Open the stopcock.
	The filter in the water inlet hose is dirty.	Clean the filter.
The <i>Check inlet</i> and <i>Check drain</i> lights are flashing. "---" appears in the display.	The water protection system has reacted.	Call the Service Department.
The <i>Soak/Pre-wash</i> or <i>Rinses</i> indicator light is flashing. "---" appears in the display.	There is a fault.	Start the programme again. If the fault indicators occur again, contact the Service Department.

- ❶ To switch off the fault indicator: switch the washing machine off with the *I-On/O-Off* button and turn the programme selector to *Finish*.

A fault indicator light comes on but the wash programme continues as normal.

Problem	Possible cause	Remedy ①
The <i>Check drain</i> light flashes.	The drain outlet is restricted.	Clean the drain filter and the drain pump as described in "Problem solving guide - Opening the drum door in the event of a blocked drain outlet and/or power failure".
The <i>Check inlet</i> light flashes.	The water inlet is restricted.	Check whether <ul style="list-style-type: none"> – the stopcock is opened wide enough. – the inlet hose is kinked.
	The filter in the water inlet hose is dirty.	Clean the filter.
The <i>Excess detergent</i> check light comes on.	Excessive foam has built up during washing.	Use less detergent next time and follow the manufacturer's instructions on dosage given on the packaging.
The <i>Main wash</i> indicator light is flashing.	There is a fault.	Start the programme again. If the fault indicator occurs again, contact the Service Department.
The <i>Anti-crease/Finish</i> indicator light is flashing.	The position of the programme selector was altered after the start of the programme. Turn the programme selector back to the programme previously chosen.	

① To switch off the fault indicator: switch the washing machine off with the *I-On/O-Off* button and turn the programme selector to *Finish*.

Problem solving guide

General problems or an unsatisfactory wash result		
Problem	Possible cause	Remedy
The machine shakes during the spin cycle.	The four feet are not resting evenly on the floor.	Level the machine. See installation.
The laundry has not been spun satisfactorily.	The spin speed selected was too low.	Select a higher spin speed next time.
The pump makes strange noises.	These do not indicate a fault. They occur at the end of a pump sequence as a normal part of the operation.	
Large residues of detergent remain in the dispenser drawer.	The water supply pressure is too low.	<ul style="list-style-type: none"> – Clean the filter in the water inlet system. – It may be useful to press the <i>Water plus</i> button.
	Washing powder used with water softener tends to become sticky.	Pour washing powder into the dispenser before adding any water softener.
Fabric conditioner is not completely dispensed or too much water remains in the  compartment.	The siphon is either incorrectly positioned or clogged.	Clean the siphon, see "Cleaning and care - Cleaning the detergent drawer".
When laundry is dry it feels hard to the touch.	Too vigorous wash action.	Programme in gentle action and more water.
	Not enough detergent used.	Increase detergent dose to prevent limescale build up in laundry.
	No fabric conditioner used.	Use fabric conditioner in last rinse.

Problem solving guide

Problem	Possible cause	Remedy
Liquid detergent does not give the required result.	Liquid detergents do not contain bleaching agents. They do not remove fruit, coffee and tea stains.	<ul style="list-style-type: none"> – Use a general purpose washing machine powder containing a bleaching agent. – Pour stain removers into compartment III of the dispenser drawer and liquid detergent into a dispenser ball. – Never put stain removers and liquid detergent together in the dispenser drawer.
Grey, greasy particles cling to washed laundry.	Insufficient amounts of detergent were used to break down the particles of grease in heavily soiled laundry.	<ul style="list-style-type: none"> – Add more detergent. – Before washing the next load run a <i>Cottons 95°C</i> programme with powder detergent but without a load.
A stale smell is in the drum and on laundry.	Low temperature washing.	Before washing the next load run a <i>Cottons 95°C</i> programme with powder detergent but without a load.
There are white residues which look like powder detergent on dark coloured laundry.	The detergent contained compounds (zeolites) to aid water softening which are not soluble in water. These have ended up on the laundry.	<ul style="list-style-type: none"> – Try and brush off the residues with a soft brush once the laundry is dry. – Use a liquid detergent to wash dark coloured textiles. Liquid detergents usually contain no zeolites.
Machine is constantly over-foaming/excess detergent light is on.	Machine connected to a water softener.	Connect machine to mains water and dose detergent for hard water.
	Too much detergent was used.	Reduce detergent.
	Too little detergent was used.	Increase detergent slightly to bring back foam suppressant ingredients.
Clothes are coming out creased.	Programme was overloaded.	Reduce quantity of clothes in drum.
	The wrong programme was used.	<ul style="list-style-type: none"> – Check care labels with section "How to wash correctly". – Use easy iron conditioners.

Problem solving guide

The drum door does not open when you press the Door button.	
Problem	Remedy
The machine is not connected to the electricity supply.	Put the plug in the socket and switch on.
The washing machine is not switched on.	Switch the machine on with the <i>I-On/O-Off</i> button.
Power cut.	Open the drum door as described in the section "Opening the door in the event of a power failure".
The door was not correctly engaged.	Press hard against the lock side of the drum door and then press the <i>Door</i> button.
There is still water in the drum and the machine is unable to drain.	Clean the fluff (drain) filter and the drain pump.
For safety reasons the drum door cannot be opened if the suds temperature is higher than 55°C.	

Opening the drum door in the event of a blocked drain outlet and/or power failure

- Switch the washing machine off.

There is a lever behind the detergent drawer fascia panel.

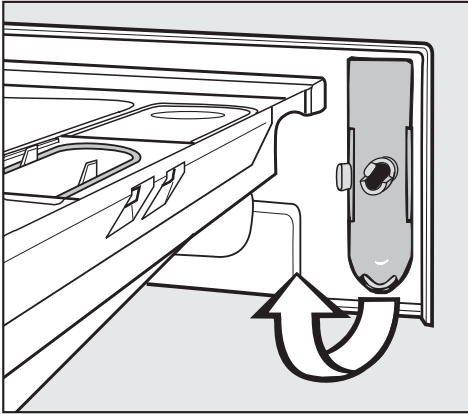

- Remove the lever.

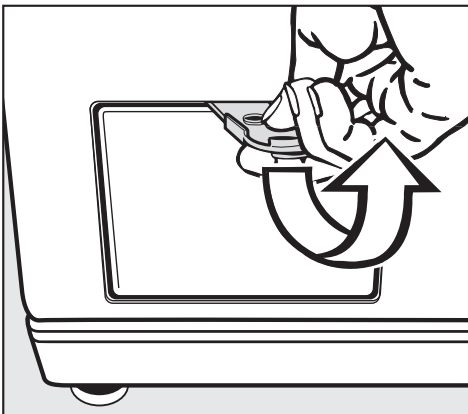

- Use it to open the access flap.

Blocked drain outlet

If the drain outlet is blocked, up to 25 litres of water will be retained in the machine.

⚠ Caution: if laundry has been washed at a high temperature, water draining out of the machine will still be hot. Danger of scalding!

Procedure for draining the machine

- Place a suitable container under the access flap.

When draining water from the machine, do **not** unscrew the drain filter completely or take it right out.



- Unscrew the drain filter lid until water runs out.

To interrupt the flow of water:

- Tighten the drain filter back up again.

Problem solving guide

Once the flow of water ceases:

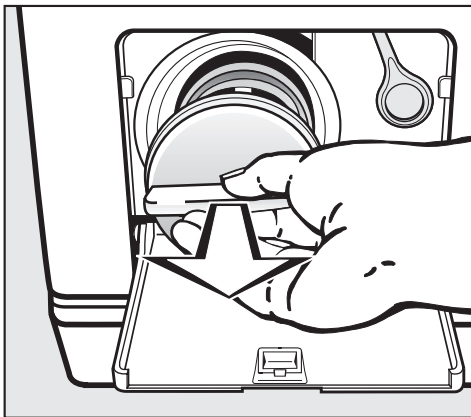

- Remove the drain filter completely.
- Clean it thoroughly.

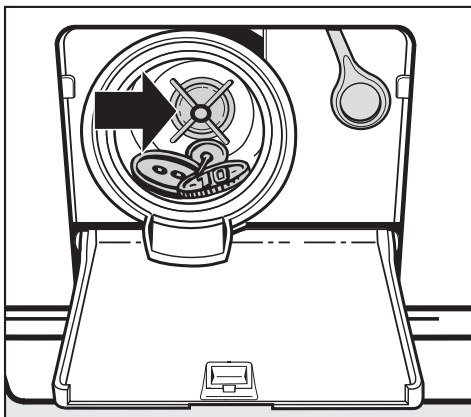

- Remove any foreign objects (e.g. buttons, coins, etc.) and fluff from the filter housing. Turn the impeller by hand to check that it rotates freely. Any foreign object causing an obstruction should be removed.
- Put the drain filter back in place and secure.

 Make sure the drain filter is securely tightened. Otherwise there is a risk of water leakage during use.

Opening the drum door

 Always make sure that the drum is stationary before reaching into the machine to remove laundry. Reaching into a moving drum is extremely dangerous.

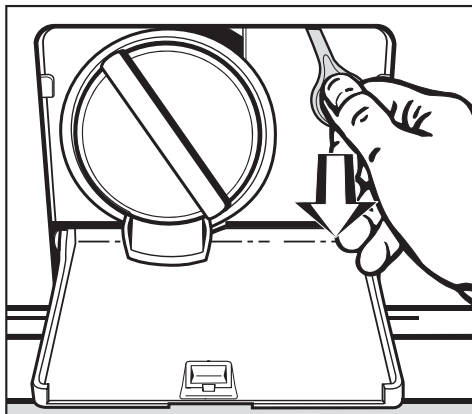

- Pull the emergency release downwards (see illustration). The drum door will open.

Customer contact

In the event of any faults which you cannot remedy yourself please contact

- Your Miele dealer or
- Your nearest Miele Service Department (see back cover for the address).

When contacting your Dealer or the Service Department, please quote the model and serial number of your appliance, both of which are shown on the data plate visible at the top inside of the door above the porthole glass when the door is open.

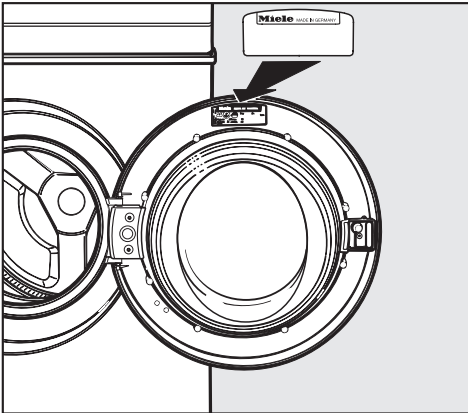

Optional accessories

Optional accessories for this washing machine are available from your Miele Dealer or from the Miele Spare Parts Department.

Please note that telephone calls may be monitored and recorded to improve our service.

Installation and connection

Front view

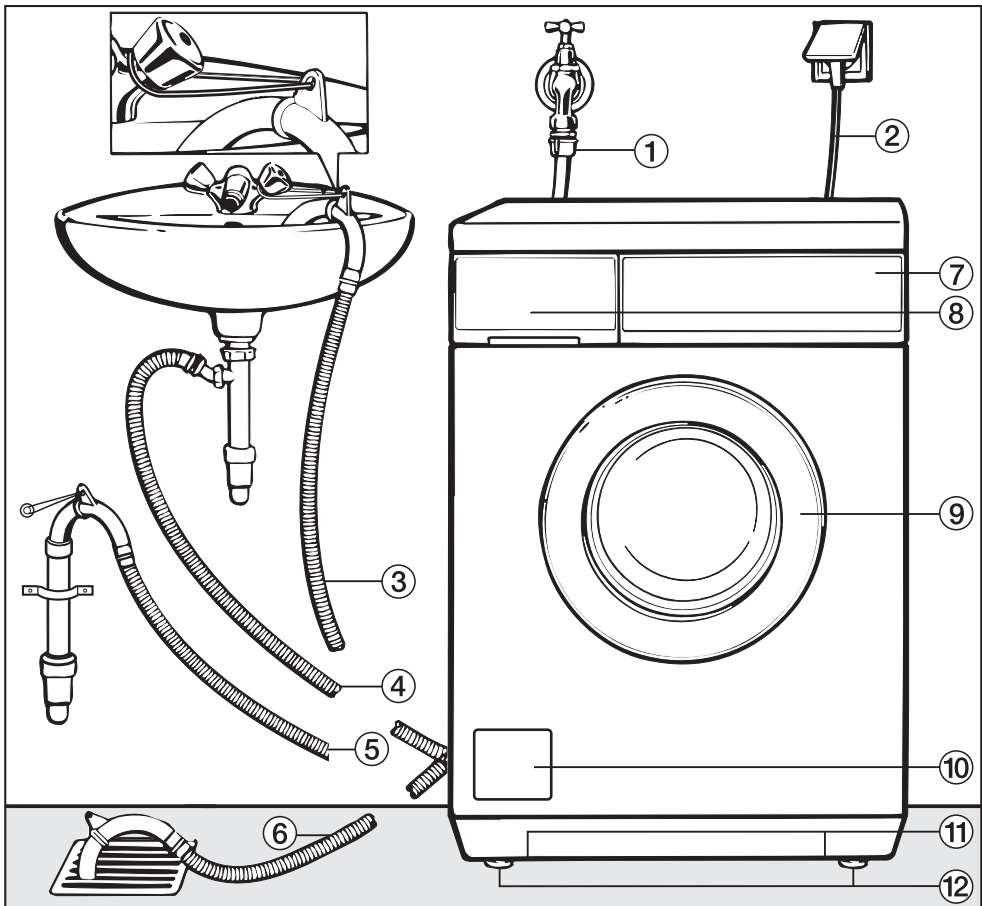

① Inlet hose (tested to withstand pressure of at least 7,000 kPa)

② Electricity supply cable

③ - ⑥ Flexible drain hose (with detachable swivel elbow)

⑦ Fascia panel with controls

⑧ Detergent dispenser drawer

⑨ Drum door

⑩ Access to fluff filter, drain pump and emergency release

⑪ Handle recesses for moving the machine

⑫ Four height adjustable feet

Rear view

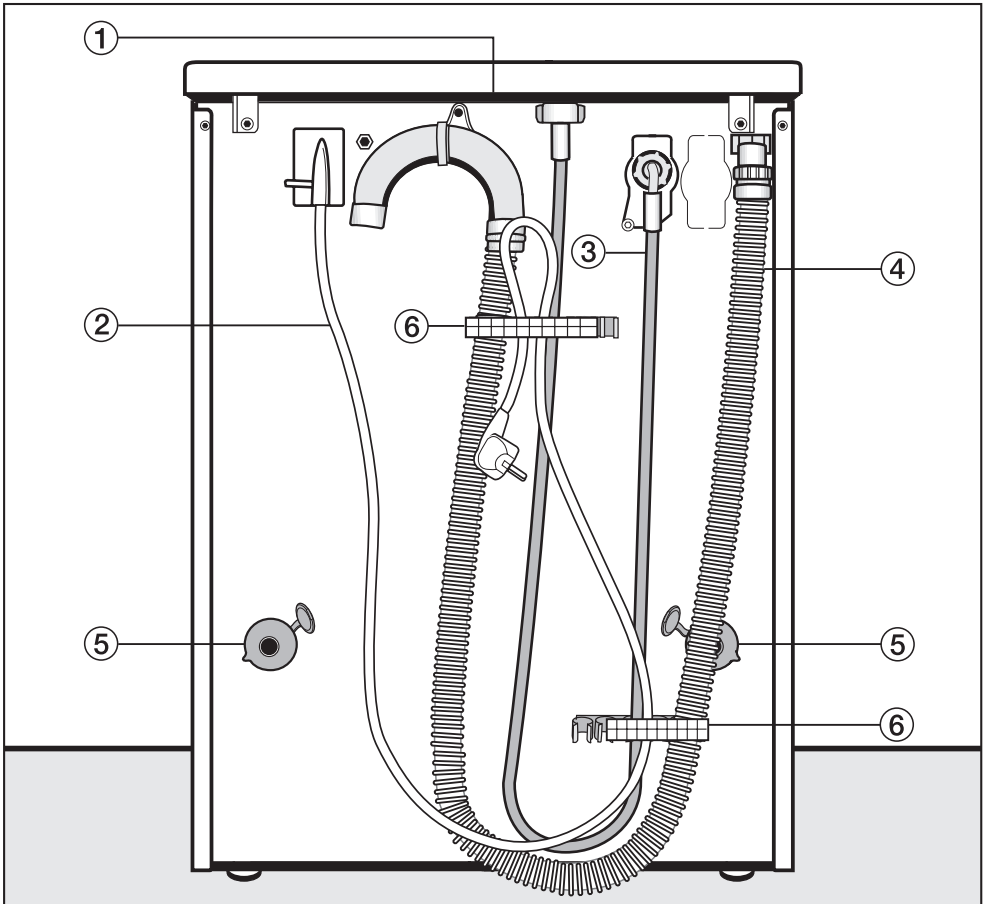

- ① Protruding lid for holding when moving the machine
- ② Electricity supply cable
- ③ Inlet hose (tested to withstand pressure of at least 7,000 kPa)
- ④ Drain hose

- ⑤ Transit bar covers
- ⑥ Restraining clip for:
 - Inlet hose
 - Drain hose
 - Electricity supply cable
 - Transit bars when removed

Installation and connection

Installation surface

A concrete floor is the most suitable installation surface for a washing machine, being far less prone to vibration during the spin cycle than wooden floorboards or a carpeted surface.

Please note the following points:

- The machine must be level and securely positioned.
- To avoid vibrations during spinning, the machine should not be installed on soft floor coverings.

If installing on a wooden joist floor:

- We recommend a plywood base (at least 59x52x3 cm). The base should span several joists and be bolted to the joists and not only to the floorboards. Check for the presence of pipes and cables.

If possible, install the machine in a corner, as this is usually the most stable part of the floor.

⚠ If the machine is installed on a raised plinth, it **has to be secured** against slippage during spinning using retaining clips (available from the Miele Spare Parts Dept).

Installing the washing machine

To manoeuvre the machine out of its packing case to its installation site hold it by the edge of the lid where it protrudes to the rear of the washing machine as well as by the handle recesses at the front.

Please note:

- Do not lift the machine by the drum door.

⚠ Ensure that the machine feet and the floor are dry to prevent the machine from slipping during the spin cycle.

Removing the transit fittings

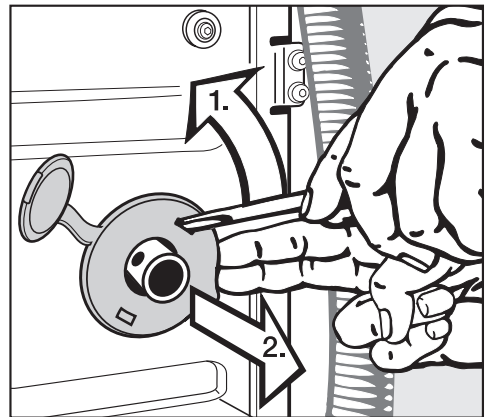

- To remove the left and right covers
 1. Use a screwdriver to prise out the cover as illustrated.
 2. Pull the cover forwards to remove.

Installation and connection

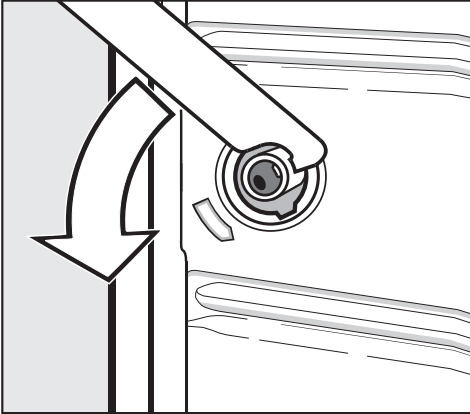

- Using the spanner supplied turn the left-hand transit bar 90°, then

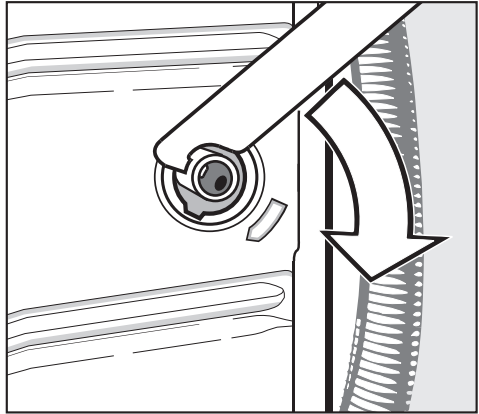

- Turn the right-hand transit bar 90°, then

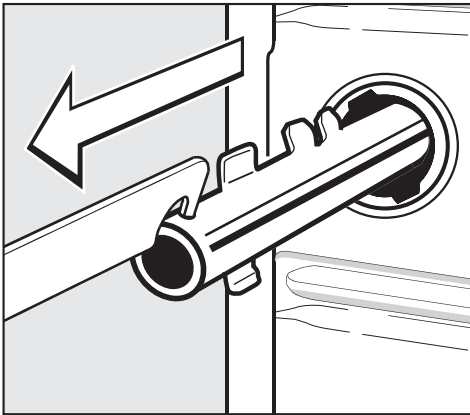

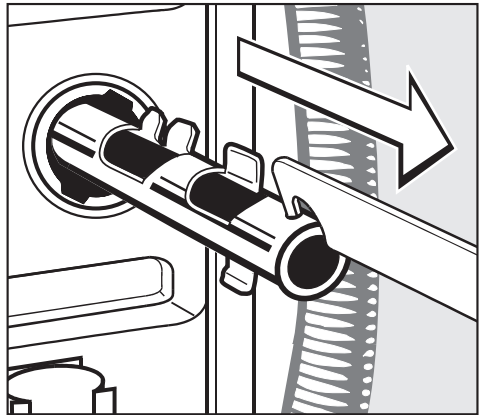

- withdraw the transit bar.

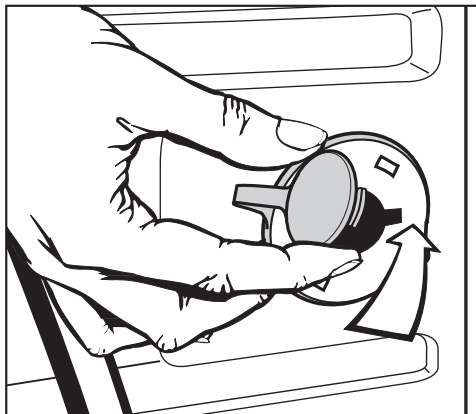

- withdraw the transit bar.

Installation and connection



 The washing machine must not be moved without the transit bars in place.

Store the transit bars as shown or keep them in a safe place for future use. They must be re-fitted if the machine is to be moved again (e.g. when moving house).

Re-fitting the transit bars

Re-fitting is carried out by reversing the procedure.

- Fit the covers on to the two holes. Then plug the holes as shown with the caps.

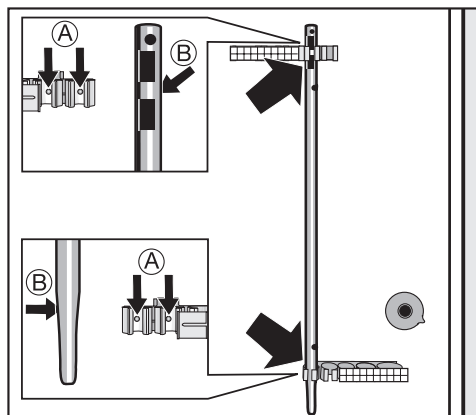

- Secure the transit bars to the back of the washing machine. Make sure that holes **(B)** are fitted over retainers **(A)**.

Levelling the machine

The machine must stand perfectly level on all four feet to ensure safe and proper operation.

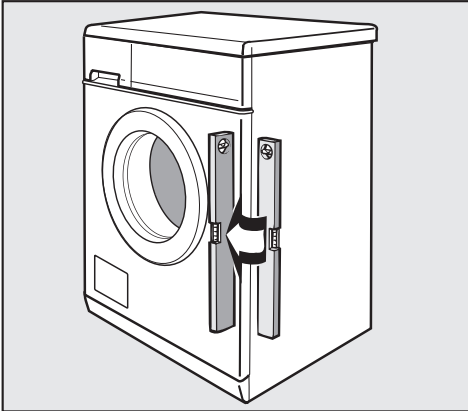

Incorrect installation may increase electricity and water consumption and may cause the machine to move about.

Screwing out and adjusting the feet

The four adjustable screw feet are used to level the machine. All four feet are screwed in when the machine is delivered.

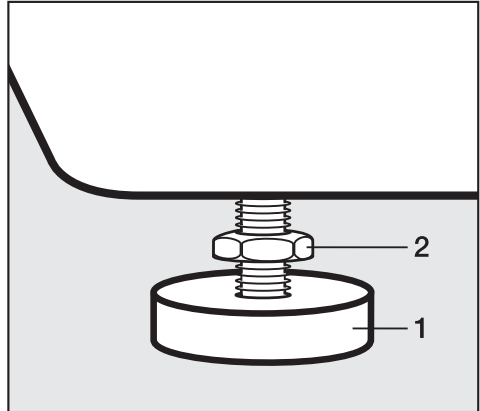

- Using the spanner supplied turn counter nut **2** in a clockwise direction. Then turn counter nut **2** together with foot **1** to unscrew.
- Use a spirit level to check the machine is standing level.
- Hold foot **1** securely with a pipe wrench. Turn counter nut **2** again using the spanner supplied until it sits firmly up against the housing.

 All four counternuts must be firmly up against the housing. Please also check this for the feet which did not need adjustment. Otherwise there is the danger of the machine moving about.

Installation and connection

The fitting of building under kits and stacking kits must only be undertaken by qualified and competent persons, in accordance with the instructions supplied with the kit.

Building under a continuous worktop/in a kitchen run

- A special building under conversion kit* is required.
The machine lid must be replaced by a cover plate. To ensure electrical safety the cover plate must be fitted.

N.B.

If you wish to push your machine under a worktop and there is space to do this **without removing the lid**, the conversion kit is not necessary. Otherwise the conversion kit is essential.

- For installation under a work surface 900/910 mm from the floor, a raising kit* is required.
- Connections for electricity, water and drainage should be installed in such a way that they remain accessible when the machine is in place.

Fitting instructions are supplied with the conversion kit.

All parts marked* are available from the Miele Spare Parts or Sales Department.

Washer and Dryer stack

A Miele tumble dryer can be stacked with the washing machine. A "WTV" stacking kit* is necessary and can be purchased from the Miele Spare Parts Department.

Please note

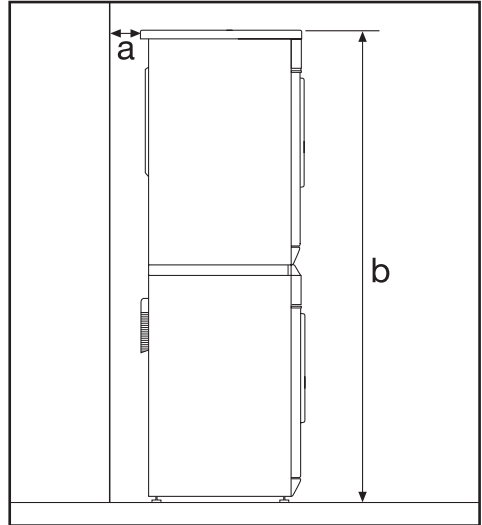

a Safety distance to wall:
at least 2 cm

b Height:
Stacking kit with pull-out shelf:
approx. 169 cm
Stacking kit without pull-out shelf:
approx. 170 cm

Replacing the lid

If the lid has been removed in order to fit a stacking kit or cover plate, ensure that, if the lid is replaced, it fits securely into the rear holders. Otherwise, it is not properly secure for transport.

The Miele water protection system

The Miele water protection system protects the washing machine from water damage.

The system consists of three main components:

- 1) the inlet hose
- 2) the electronic unit and the washing machine housing
- 3) the drain hose

1) Inlet hose

The inlet hose can withstand pressure of more than 7,000 kPa.

2) Electronic unit and washing machine housing

- Sump

Any leaking water is collected in a sump in the base of the machine. A float switches off the safety valves, preventing any more water flowing into the machine and water in the suds container is pumped away.

- Overflow protection

This prevents the washing machine taking in too much water. If the water level exceeds a certain level, the drain pump switches in and pumps the excess water away.

3) Drain hose

The drain hose is protected by a ventilation system which prevents the washing machine from being emptied completely.

Installation and connection

Connection to the water supply

The machine should be connected to a mains water supply in accordance with local and national safety regulations. The German authorities do not require it to have a non-return valve as the washing machine has been designed to comply with DIN regulations.

The machine is designed to operate with a flow pressure of between 100 kPa and 1,000 kPa. If it is higher than 1,000 kPa it is essential to fit a reducer valve.

Connection to the mains water supply should incorporate a mains stopcock with $\frac{3}{4}$ " thread. The stopcock should be fitted by a qualified plumber.

 The connection point is subject to mains water pressure. Turn on the stopcock slowly and check for leaks. Correct the position of the washer and union if appropriate.

The washing machine is **not** suitable for connection to a hot water supply and connection to a household water softener is not recommended.

In order to protect the water inlet valve, the two dirt filters - one in the open end of the inlet hose, one at the inlet point in the machine must not be removed.

Extension hose

- Longer hoses 2.5 or 4.0 m in length are available from your Miele dealer or the Miele Spare Parts Department as optional extras.

Maintenance and care

Only use a genuine Miele hose should you ever need a replacement or extension. These are tested to withstand pressure of at least 7,000 kPa.

Connection to the drainage system

The machine drains via a drain pump with a delivery head of 1 metre*.

The drain hose must not be kinked as this restricts drainage. The swivel elbow at the end of the hose can be turned in either direction, or can be detached if required, with a sharp twist and pull.

If required, the drain hose can be extended to a length of 5 m. The necessary parts can be purchased from the Miele Spare Parts Department or your Miele dealer.

* For a delivery head of more than 1 m (up to a maximum of 1.8 m) a second duo-drain pump is available with the corresponding kit from the Miele Spare Parts Department or your Miele Dealer.

Drain hose connection:

1. Direct into a sink or basin:

Please note the following

- Hook the hose over the edge and secure.
 - Make sure that the water can drain away freely without hindrance. Otherwise there is a risk of water overflowing or of some of the drained water being sucked back into the machine.
2. Connected securely to a plastic drain pipe with a rubber nipple. There is no need to use a non-return valve.
 3. Connected securely to a standpipe.
 4. Connected securely to a floor gully.

Installation and connection

Electrical connection U.K.

All electrical work should be carried out by a suitably qualified and competent person, in strict accordance with national and local safety regulations.

Ensure power is not supplied to the appliance until after installation work has been carried out.

The appliance is supplied with a mains cable with moulded plug ready for connection to a 230-240V mains supply. **The voltage and connected load are given on the data plate.**

Please ensure these match the household mains supply. The fuse rating is quoted on the plug.

Connection should be made via a suitable switched socket which is easily accessible after installation.

For extra safety it is advisable to install a residual current device (RCD), with a trip current of 30 mA (in accordance with DIN VDE 0664, VDE 0100 Section 739).

Do not connect via an extension lead. Extension leads do not guarantee the required safety of the appliance (e.g. danger of overheating).



Non-rewireable plugs BS 1363

The fuse cover must be refitted when changing the fuse, and if the fuse cover is lost, the plug must not be used until a suitable replacement is obtained. The colour of the correct replacement cover is that of the coloured insert in the base of the plug, or the colour that is embossed in words on the base of the plug (as applicable to the design of plug fitted).

Replacement fuses should be ASTA approved to BS 1362 and have the correct rating. Replacement fuses and fuse covers may be purchased from your local electrical supplier.

**WARNING: THIS APPLIANCE
MUST BE EARTHED**

Consumption data

	Load	Consumption data			
		Energy in kWh	Water in litres	Duration	
				Normal	Intensive
Cottons					
95°C	5.0 kg	1.70	45	1 h 42 min	1 h 57 min
60°C ¹⁾	5.0 kg	0.85	45	–	1 h 56 min ¹⁾
60°C	5.0 kg	0.85	45	1 h 26 min	1 h 56 min
40°C ¹⁾	5.0 kg	0.50	45	–	1 h 56 min ¹⁾
40°C	5.0 kg	0.50	45	1 h 26 min	1 h 56 min
Minimum iron					
40°C ¹⁾	2.5 kg	0.45	49	–	1 h 16 min ¹⁾
40°C	2.5 kg	0.45	49	1 h 01 min	1 h 16 min
Delicates					
30°C	1.0 kg	0.35	65	49 min	59 min
Silks 					
30°C	1.0 kg	0.24	39	37 min	–
Woollens 					
30°C	2.0 kg	0.23	37	40 min	–
Quick wash					
40°C	2.5 kg	0.35	35	31 min	–
Automatic					
40°C	3.0 kg	0.30 - 0.60	30 - 50	54 min	1 h 09 min

¹⁾ EN 60456 test programme

Note for test institutes:

For testing in accordance with EN 60456 you must use the *Intensive* option.

Consumption data can vary from the nominal values given depending on water pressure, water hardness, water inlet temperature, room temperature, type and volume of load, fluctuations in the electricity supply and any additional options selected.

Technical data

Height	85.0 cm
Width	59.5 cm
Depth	58.0 cm
Depth with door open	97.5 cm
Weight	93 kg
Maximum floor load	1600 Newton (approx. 160 kg)
Capacity	5 kg dry laundry
Voltage	see data plate
Rated load	see data plate
Fuse rating	see data plate
Consumption data	see "Consumption data"
Water flow pressure minimum	100 kPa (1 bar)
Water flow pressure maximum	1000 kPa (10 bar)
Inlet hose length	1.60 m
Drain hose length	1.50 m
Connection cable length	1.60 m
Drain pump head max.	1.00 m
Drain pump length max.	5.00 m
Test certificates awarded	Radio / TV suppression, VDE

Programmable functions for changing standard settings

Programmable functions

The programmable functions can be used to tailor washing programmes to suit your individual requirements.

The programmable functions are activated with the help of the *Start* button and the programme selector.

Water plus system

Selecting the *Water plus* additional option increases the water intake in the programmes listed below.

The water intake is increased in the wash and rinse stages and in the *Cottons* and *Minimum iron* programmes an extra rinse cycle is introduced.

There are four different settings which can be programmed to alter the water intake for the following programmes:

- Cottons
- Minimum iron
- Quick wash
- Automatic
- Silks

The programmed setting is then activated by pressing the *Water plus* additional option button.

The settings are as follows:

Setting 1:

an increase in the rinse water level for the programmes listed.

Setting 2:

an increase in the water level in the main wash and rinses for the programmes listed (the washing machine is delivered with setting 2 programmed as standard).

Setting 3:

an extra rinse cycle in the *Cottons* and *Minimum iron* programmes.

Setting 4:

an increase in the water level in the main wash and rinses for the programmes listed and also an extra rinse cycle in the *Cottons* and *Minimum iron* programmes. This setting should be programmed in if laundry is too hard after drying and if someone in the household suffers from a detergent allergy.

Programmable functions

Follow steps ① to ⑦ to programme and store a setting in memory.

Before you begin, first ensure that:

- The washing machine is switched off.
- The machine is properly closed.
- The programme selector is at *Finish*.

- ① Press the *Start* button and keep it pressed in whilst carrying out steps ② to ③.
- ② Switch the machine on with the *I-On/O-Off* button.
- ③ Wait until the *Start* indicator light comes on . . .
- ④ . . . and then release the *Start* button.

- ⑤ Turn the programme selector to the *Cottons 75°C* position:

A *P* will flash in the display alternating with the number *1*, *2*, *3* or *4*.

- ⑥ Each subsequent press on the *Start* button selects a different setting.

The number alternating with the *P* in the display refers to the settings as follows:

- 1 = Setting 1 is selected
(increased water level in the rinses)
 - 2 = Setting 2 is selected
(increased water level in the main wash and in the rinses)
 - 3 = Setting 3 is selected
(extra rinse in the *Cottons* and *Minimum iron* programmes)
 - 4 = Setting 4 is selected
(increase in the water level in the main wash and rinses and also an extra rinse in the *Cottons* and *Minimum iron* programmes).
- ⑦ Switch the washing machine off with the *I-On/O-Off* button.

The *Water plus* button has now been allocated the setting you have chosen. This setting will remain in memory until another setting is programmed.

Programmable functions

Gentle action

Activating gentle action reduces the drum action and is suitable for washing slightly soiled items more gently. It should be activated for garments with a single bar under the care label and for articles which feel too hard after they have been dried.

Gentle action can be used with the *Cottons*, *Quick wash*, *Starch* and *Automatic* programmes.

If "Gentle action" is programmed into the machine, every wash cycle in these programmes will be carried out with gentle action rhythm.

The washing machine is delivered with "Gentle action" de-activated.

Follow steps ① to ⑦ to programme and store in memory.

Before you begin, first ensure that:

- The washing machine is switched off.
- The machine is properly closed.
- The programme selector is at *Finish*.

① Press the *Start* button and keep it pressed in whilst carrying out steps ② to ③.

② Switch the machine on with the *I-On/O-Off* button.

③ Wait until the *Start* indicator light comes on . . .

④ . . . and then release the *Start* button.

⑤ Turn the programme selector to the *Cottons 60°C* position:

A *P* will flash in the display alternating with the number *0* or *1*.

0 = Gentle action is deactivated.

1 = Gentle action is activated

⑥ Press the *Start* button to change from one to the other. The display will change accordingly from *0* to *1* or from *1* to *0*.

⑦ Switch the washing machine off with the *I-On/O-Off* button.

The setting you have selected is now stored in memory and will remain so until you alter it.

Top-up rinse for Cottons

When this is activated, additional water flows into the drum at the end of the main wash to cool the suds down. Hot suds can damage plastic drainage pipes.

Top-up rinse takes place when temperatures of 95°C and 75°C are selected.

Top-up rinse should be activated:

- to prevent the danger of scalding if the drain hose is hooked over the edge of a sink or basin.
- where the drainage pipes do not comply with DIN 1986.

The washing machine is delivered with the Top-up rinse for *Cottons* deactivated.

Follow steps ① to ⑦ to programme and store in memory.

Before you begin, first ensure that:

- The washing machine is switched off.
- The machine is properly closed.
- The programme selector is at *Finish*.

- ① Press the *Start* button and keep it pressed in whilst carrying out steps ② to ③.
- ② Switch the machine on with the *I-On/O-Off* button.
- ③ Wait until the *Start* indicator light comes on . . .
- ④ . . . and then release the *Start* button.
- ⑤ Turn the programme selector to the *Cottons 40°C* position:
A *P* will flash in the display alternating with the number *0* or *1*.
0 = Top-up rinse is deactivated
1 = Top-up rinse is activated
- ⑥ Press the *Start* button to change from one to the other. The display will change accordingly from *0* to *1* or from *1* to *0*.
- ⑦ Switch the washing machine off with the *I-On/O-Off* button.

The setting you have selected is now stored in memory and will remain so until you alter it.

Programmable functions

Memory Function

If an additional option(s) is selected for a programme, and / or the spin speed is altered, the machine stores these changes in memory at the start of a programme.

When that particular programme is chosen again, the display will show the additional option(s) and / or spin speed which have been stored for that programme in the memory.

The washing machine is delivered with the memory function de-activated.

Follow steps ① to ⑦ to programme and store in memory.

Before you begin, first ensure that:

- The washing machine is switched off.
- The machine is properly closed.
- The programme selector is at *Finish*.

① Press the *Start* button and keep it pressed in whilst carrying out steps ② to ③.

② Switch the machine on with the *I-On/O-Off* button.

③ Wait until the *Start* indicator light comes on . . .

④ . . . and then release the *Start* button.

⑤ Turn the programme selector to the *Cottons 30°C* position:

A *P* will flash in the display alternating with the number *0* or *1*.

0 = Memory function is deactivated

1 = Memory function is activated

⑥ Press the *Start* button to change from one to the other. The display will change accordingly from *0* to *1* or from *1* to *0*.

⑦ Switch the washing machine off with the *I-On/O-Off* button.

The setting you have selected is now stored in memory and will remain so until you alter it.

Soak

A length of time of between 30 minutes and 2 hours can be programmed in 30 minute increments for the soak process.

If the soak option is pressed the selected soak time will be carried out for the period selected before the wash programme is run.

The machine is set as standard to a two hour soak time.

Follow steps ① to ⑦ to programme and store in memory.

Before you begin, first ensure that:

- The washing machine is switched off.
- The machine is properly closed.
- The programme selector is at *Finish*.

① Press the *Start* button and keep it pressed in whilst carrying out steps ② to ③.

② Switch the machine on with the *I-On/O-Off* button.

③ Wait until the *Start* indicator light comes on . . .

④ . . . and then release the *Start* button.

⑤ Turn the programme selector to the *Minimum iron 60°C* position:

A *P* will flash in the display alternating with the number *1*, *2*, *3* or *4*.

⑥ Each subsequent press on the *Start* button selects a different setting.

The number alternating with the *P* in the display refers to the settings as follows:

1 = the soak time is 2 hours
(default setting)

2 = the soak time is 1 hour 30 minutes

3 = the soak time is 1 hour

4 = the soak time is 30 minutes

⑦ Switch the washing machine off with the *I-On/O-Off* button.

The setting you have selected is now stored in memory and will remain so until you alter it.

United Kingdom:

Miele Co. Ltd.
Fairacres, Marcham Road
Abingdon, Oxon, OX14 1TW
tel. Abingdon (01235) 554455
Service Office: (01235) 554466
fax (01235) 554477
Internet: www.miele.co.uk

Ireland:

Miele Ireland Ltd.
Broomhill Road, Tallaght, Dublin 24
Tel: (01) 46 10 710, Fax: (01) 46 10 797
Email: info@miele.ie
Internet: <http://www.miele.ie>

Australia:

Miele Australia Pty. Ltd.
A.C.N. 005635398
1 Gilbert Park Drive
Knoxfield, VIC 3180
Telephone: (03) 9764 7100
Fax: (03) 9764 7129
Internet: www.miele.com.au

Distributor New Zealand:

Steelfort Engineering Company. Ltd.
500 Rangitikei Street
Palmerston North, Priv. Bag 11045, NZ
Telephone: (06) 350 1350
Fax: (06) 356 1507

South Africa:

Miele (Pty) Ltd
63 Peter Place
Bryanston 2194
P.O. Box 69434
Bryanston 2021
Tel.: (011) 548 1900
Telefax (011) 548 1935
Internet: www.miele.co.za
E-mail: info@miele.co.za

Singapore:

Miele Southeast Asia
Miele Pte. Ltd.
163 Penang Road
04 - 02/03 Winsland House II
Singapore 238463
Tel : +65-67351191
Fax: +65-67351161
Email: infosea@miele.com.sg

Hong Kong:

Miele (Hong Kong) Limited
AIA Plaza, 24th Floor
18 Hysan Avenue
Causeway Bay
Hong Kong
Tel.: (852) 2610 1331
Fax: (852) 2610 1013
E-mail: mielehk@miele.com.hk